

Oxlife INDEPENDENCE[®]



USER MANUAL

PORTABLE OXYGEN CONCENTRATOR

USER: READ THIS MANUAL BEFORE OPERATING THIS DEVICE.
SAVE THIS MANUAL FOR FUTURE REFERENCE.

HEALTH-CARE PROVIDER: THIS MANUAL MUST BE PROVIDED TO THE END USER.



American Medical Sales and Rentals

15055 E. Hinsdale Drive, Bldg D
Centennial, CO 80112
Phone: +1 (877) 774-9271

www.oxygenconcentratorstore.com
E-mail: sales@amsrco.com



PROUDLY ASSEMBLED IN THE U.S.A.

Table of Contents

| | |
|---|----|
| Section 1: Introduction | 7 |
| Intended Use | 8 |
| User Profile | 8 |
| Symbols Reference/Safety Information | 9 |
| Device Symbols | 10 |
| Specifications | 11 |
| Contraindications | 12 |
| Indications for Use | 13 |
| Dynamic Network Analysis | 14 |
| Section 2: Safety Guidelines | 15 |
| Device Safety Guidelines | 15 |
| Patient Safety Guidelines | 17 |
| Battery and Power Supply Safety Guidelines | 20 |
| Section 3: Product Description | 22 |
| Device and Accessories | 22 |
| Feature Identification | 23 |
| Understanding the Control Panel | 24 |
| Applied Parts | 25 |
| Section 4: Operating Instructions | 26 |
| Before Operating | 26 |
| Locating Your Device | 27 |
| Device Settings | 28 |
| Installing and Removing the Battery | 31 |
| Typical Battery Operation Times | 31 |
| Battery Time Management | 32 |
| AC Power Supply | 34 |
| DC Power Supply | 36 |
| DC Power Supply User Information Guide | 38 |
| DC Power Supply Troubleshooting Guide | 39 |

| | |
|--|----|
| Handle Operation | 40 |
| Accessory Bag | 41 |
| Cannula Use | 42 |
| Accessing the Provider Screen and Changing Languages | 43 |
| Section 5: User Alerts and Alarms | 46 |
| Alarm and Alert Screens | 46 |
| Alarm and Alert Screen Descriptions..... | 47 |
| Alarm System Test | 53 |
| Section 6: Maintenance and Cleaning | 57 |
| Maintenance | 57 |
| Pre-Use Functional Check | 57 |
| Device Care and Cleaning..... | 58 |
| <i>Air Inlet Filter Cleaning</i> | 58 |
| <i>Cleaning</i> | 59 |
| <i>AC and DC Power Supplies and Cords</i> | 59 |
| <i>Disinfection</i> | 59 |
| Battery Disposal..... | 60 |
| Device Disposal..... | 60 |
| Section 7: Traveling | 61 |
| Entering and Exiting Airplane Mode | 62 |
| Section 8: Standards Compliance | 64 |
| Classification | 65 |
| INDEPENDENCE® – LIMITED WARRANTY STATEMENT..... | 71 |
| PRODUCT RETURN GUIDELINES..... | 74 |
| NOTES..... | 75 |

Section 1: Introduction

PLEASE READ THIS OPERATION MANUAL CAREFULLY BEFORE USING THIS DEVICE. BE AWARE OF ALL WARNINGS AND SAFETY INFORMATION. ONLY USE ACCESSORIES APPROVED BY O2 CONCEPTS AND REFERENCED WITHIN THIS MANUAL.

IF YOU DO NOT FULLY UNDERSTAND ALL THE WARNINGS, SAFETY PRECAUTIONS, AND OPERATING INSTRUCTIONS CONTACT YOUR AUTHORIZED DEALER OR HEALTHCARE PROVIDER FOR TECHNICAL SUPPORT.

Please contact your authorized dealer or healthcare provider if your Independence requires service.

Please call O2 Concepts Technical Support to report any unexpected operation or events associated with the device at 1-800-867-4008 EXT 367.

Information about the Independence and O2 Concepts can also be found on our website at www.O2-concepts.com.

CAUTION: U.S. FEDERAL LAW RESTRICTS THESE DEVICES TO SALE BY OR ON THE ORDER OF A PHYSICIAN.

Intended Use

The Oxlife Independence® is a portable oxygen concentrator used on a prescriptive basis that enables patients requiring supplemental oxygen to be treated in a home, institutional, or vehicle/mobile environment.

The Independence delivers 87%-95% pure oxygen to a patient through a standard single lumen nasal cannula.

The Independence detects a patient breath and delivers a bolus of oxygen during the inhalation period in pulse mode or delivers a continuous flow of oxygen in continuous mode.



















The Independence can be set to deliver flowrates in pulse mode settings of 0.5 to 6.0 of 8ml – 96ml and in continuous mode of 0.5 to 3.0 liters per minute (LPM). Setting can be adjusted in increments of 0.5 for both modes.

The Independence has standard power options include a 100-240V AC power supply, 10-15V DC power supply and rechargeable lithium ion batteries.

User Profile











The Independence is suitable for adult patients with chronic pulmonary diseases such as chronic bronchitis, emphysema, asthma, or lung cancer, those in the terminal stages of cancer or any patient requiring supplemental oxygen.

Symbols Reference/Safety Information

| ICON | MEANING | ICON | MEANING |
|---|--|---|--|
|  | Caution represents the possibility of damage to the equipment |  | Warning represents the possibility of harm to the operator or patient |
|  | No smoking while using or near device |  | Not suitable for use in the presence of a flammable anesthetic mixture |
|  | No open flames |  | Do not incinerate battery |
|  | Indoor Use Only* |  | Use no grease or oils |
|  | Do not disassemble |  | Do not dispose of in household waste |
|  | Refer to instructions |  | Keep dry in transport and storage |
|  | Type BF equipment |  | Class II equipment |
|  | Recycle battery |  | Prescription only |
| IP22 | Drip proof equipment |  | Manufacturer |
|  | Alternating current |  | Direct current |

*Refers to AC and DC power supplies, not the Independence device.

Device Symbols

| ICON | MEANING | ICON | MEANING |
|---|-----------------------|---|---|
|  | Power button |  | Breath detection |
|  | Mode button |  | Battery life indication |
|  | Continuous Mode |  | AC/DC power |
|  | Pulse Mode |  | AC/DC charge indication |
|  | Increase flow setting |  | Contains Dynamic Network Analysis® (DNA) technology |
|  | Decrease flow setting | | |

Specifications

| DIMENSIONS | |
|--------------------------------------|---|
| Device Dimensions with Handle/Wheels | H: 20.29 in H: 51.5 cm W: 10.85 in W: 27.55 cm D: 9.45 in D: 24 cm |
| WEIGHTS | |
| Device Weight | 16.7 lbs. (7.57 kg) |
| Cart Kit (Wheels & Pull Handle) | 2.17 lbs. (0.98 kg) |
| Battery | 1.4 lbs. (0.63 kg) |
| AC Charger | 1.9 lbs. (0.86 kg) |
| DC Charger | .37 lbs. (0.16 kg) |
| MODES OF OPERATION | |
| Continuous Flow | 0.5 to 3 LPM in 0.5 LPM increments; Maximum deviation in flow rate is $\pm 15\%$. Max flow 3.0 LPM. Flow maintained with outlet pressure ranging from 0 to 5.0 psig (0-34kPa) |
| Pulse Dose | 0.5 to 6.0 (8mL-96mL) setting increments; Maximum deviation of volume per breath is $\pm 15\%$ across all environmental conditions. |
| Breath Sensitivity | The device will deliver bolus based on a trigger pressure range of -0.08 to -0.35 cmH ₂ O. |
| Battery Specification | 14.4V Lithium Ion Battery |
| External Power Supply Power Input | AC power: 100 - 240 VAC, 50/60 Hz@ 2.5 amps DC power: 12-15 VDC; Recommended: 15A outlet at 12V |
| Operating Altitude | 0-13,123ft or (0-4000m) |
| Oxygen Purity | 91% \pm 4% (87 - 95%) from 0.5 to 3.0 LPM; Measured purity values are within $\pm 2\%$ of actual values; There is no variation in purity within the operating altitude. This applies to the full range of environmental operating conditions. |
| Operating Temperature | 50°F (10°C) to 104°F (40°C) |
| Operating Humidity | 10% - 95% @ 82.4°F (28°C) |
| Operating Atmospheric Pressure | 101kPa to 63kPa |
| Operating Environment | Free of smoke, pollutants, and fumes. |
| Transport/ Storage Temperature | -4°F (-20°C) to 140°F (60°C) |
| Transport/ Storage Humidity | 0 -95% non-condensing |
| Operating Time | 24 hours per day when connected to an external AC or DC power source. This is a continuous operation device. |
| Cannula Specification | DO NOT use cannula tubing longer than 7ft (2.13m) when using Pulse Flow Mode Do NOT use cannula tubing longer than 50ft (15.25m) when using Continuous Flow Mode. |
| A-Weighted Sound Pressure Level | The volume that the device will reach at maximum settings will be ~ 56dBA with maximum peaks of 58.8dBA. |
| Alarm Sound Level | All alarms triggered by the device will be 85dBA or higher at 10cm from the unit. |
| Maximum Outlet Pressure | Device will maintain flow up to 5psi back pressure. Maximum back pressure is 7.0psi. |
| Service Life | Device: 5yrs, Accessories: 1yr |

Contraindications

- ⚠ Under certain circumstances, the use of non-prescribed oxygen therapy can be hazardous. This device should only be used when prescribed by a physician.
- ⚠ Not for use in the presence of aerosol sprays or flammable anesthetics.
- ⚠ Additional monitoring may be required for patients using this device who are unable to hear or see alarms or communicate discomfort.
- ⚠ The Independence is not appropriate for any patient who would experience adverse health consequences as a result of a temporary interruption in oxygen therapy.
- ⚠ The availability of an alternate source of supplemental oxygen is strongly recommended in the case of power interruption or a mechanical failure of the device. Consult your healthcare provider for a recommendation of an alternate source of oxygen.
- ⚠ It is the patient's responsibility to arrange for an alternate oxygen supply when traveling. O2 Concepts assumes no liability for persons choosing not to adhere to manufacture recommendations.
- ⚠ This device is for adult use only. It is not qualified for use by pediatric patients.
- ⚠ This device is not qualified for use by patients with a tracheotomy.

Indications for Use

- ⚠ The O2 Concepts Oxlife Independence® is indicated on a prescription basis for the administration of supplemental oxygen. It is not intended for life support, nor does it provide any patient monitoring capabilities.

Dynamic Network Analysis

This version of the Oxlife Independence® contains Dynamic Network Analysis (DNA) technology which is available to allow your health care provider to better serve your needs. This technology is intended to assist your provider in determining that your device continues to operate within specification.

This device is FAA approved for use aboard passenger aircraft (FAA Advisory Circular 91.21-1B), including radio frequency emission limits of (RTCA) Document (DO) 160, section 21, Category M. Device contains FCC Id R5Q-LISAC200A or FCC Id XPY2AGQN4NNN.

The cellular connection must be deactivated prior to flight on any commercial aircraft.

Instructions for deactivating the cellular connection are listed on page 63 and 64 within Section 7: Entering and Exiting Airplane Mode.

There is no known interference posed by medical equipment during specific investigations or treatments.

There are no known devices that will cause interference issues.



Section 2: Safety Guidelines

Device Safety Guidelines

- ❗ **AVOID EXPOSURE TO OPEN FLAMES OR CREATION OF ANY SPARK NEAR YOUR INDEPENDENCE. THIS INCLUDES SPARKS FROM STATIC ELECTRICITY CREATED BY ANY TYPE OF FRICTION. PROTECT ELECTRICAL POWER CORDS FROM SHARP EDGES TO AVOID ELECTRICAL SHOCK AND SERIOUS PHYSICAL INJURY.**
- ❗ Locate the Independence in a well-ventilated area to allow for adequate air intake. Avoid the intake of airborne pollutants, smoke, or fumes.
- ❗ Use of this equipment adjacent to or stacked with other equipment should be avoided as it could result in improper operation.
- ❗ Use only approved accessories as specified in this User Manual. Use of non-approved accessories may cause serious damage to the device and will void the warranty.
- ❗ Use only parts recommended by the manufacturer to ensure proper function and to avoid the risk of fire and burns.
- ❗ Incompatible parts or accessories can result in degraded performance.
- ❗ Locate oxygen tubing and power cords away from hot surfaces and in a manner to prevent tripping hazards.
- ❗ Wind or strong draughts can adversely affect accurate delivery of oxygen therapy.
- ❗ **DO NOT** modify the device. Any modifications made to the device may impair performance or damage equipment and will void the warranty.
- ❗ **DO NOT** operate the device in an enclosed space, such as a closet as it will impair device function.

- ❗ **DO NOT** cover the device or block the air inlet or the exhaust ports located on the sides of the device as it may impair device function.
- ❗ **DO NOT** drop or insert any objects or liquid into any opening.
- ❗ **DO NOT** leave your Independence or batteries in your vehicle or trunk. Extreme hot or cold may damage your device and or batteries.
- ❗ **DO NOT** ship the Independence with the batteries installed. Batteries must be shipped separately and packaged appropriately to avoid damage.
- ❗ Keep the device away from potential household pests to avoid infestation that will impair device performance and will void the warranty.
- ❗ Portable RF communications equipment (including peripherals such as antenna cables and external antennas) should be used no closer than 12 inches (30cm) to any part of the Independence including cables specified by the manufacturer. Otherwise, degradation of the performance of this equipment could result.
- ❗ Use of accessories, transducers, or cables other than those specified by O₂ Concepts could result in increased electromagnetic emissions or decreased electromagnetic immunity of the device and result in improper operation.
- ❗ Use of the device adjacent to or stacked with other equipment should be avoided because it could result in improper operation. If such use is necessary, the device as well as other stacked equipment should be observed to verify that they are operating normally.
- ❗ The device is suitable to use in a CISPR 11 Group 1 Class B environment for radiated emissions.

Patient Safety Guidelines

- ⚠ **DO NOT SMOKE WHILE USING THIS DEVICE. KEEP ALL MATCHES, LIT CIGARETTES, CANDLES, OR OTHER SOURCES OF IGNITION AT LEAST 10 FEET FROM THE DEVICE. THIS DEVICE PRODUCES ENRICHED OXYGEN GAS WHICH ACCELERATES COMBUSTION.**
- ⚠ **PRESCRIBED MODE AND FLOW SETTINGS SHOULD ONLY BE ADJUSTED UNDER THE ADVICE OF A PHYSICIAN.**
- ⚠ Outdoor use must be conducted using battery power.
- ⚠ Keep unit away from children, pets, and potential household pests.
- ⚠ Keep cannula tubing away from children and pets to avoid danger of choking or strangulation.
- ⚠ Use caution as small parts may pose a choking hazard.
- ⚠ If you feel discomfort or are experiencing a medical emergency while undergoing oxygen therapy, seek medical assistance immediately to avoid harm.
- ⚠ **DO NOT** remove any small parts or fasteners from unit. Small parts can cause injury if inhaled or swallowed.
- ⚠ **DO NOT** use the device with a damaged power cord or plug to avoid injury.
- ⚠ **DO NOT** operate the device on wet surfaces or in standing water, and do not submerge or expose to water or precipitation to avoid serious injury or damage to the device. If the Independence has been dropped, damaged or exposed to water please contact your authorized dealer or healthcare provider for inspection and possible service of the device.

- ⚠ **DO NOT** come in contact with the device when wet to avoid serious injury or the chance of shock.
- ⚠ Use only water-based lotions or salves that are oxygen compatible before and during oxygen therapy. **DO NOT** use oil, grease, or petroleum-based products on or near the device to prevent accidental ignition.
- ⚠ **DO NOT** lubricate fittings, connections, tubing or other accessories to avoid the risk of fire and burns.
- ⚠ **DO NOT** use the device with an extension cord.
- ⚠ There is a risk of fire associated with oxygen enrichment during oxygen therapy. Do not use the oxygen concentrator or accessories near sparks or open flames.
- ⚠ Open flames during oxygen therapy are dangerous and are likely to result in fire or death. **DO NOT** allow open flames within ten (10) feet (1.6 m) of the oxygen concentrator or any oxygen carrying accessories.
- ⚠ Oxygen makes it easier for a fire to start and spread. **DO NOT** leave the nasal cannula or mask on bed coverings or chair cushions. If the oxygen concentrator is turned on, but not in use, the oxygen will make the materials flammable. Turn the oxygen concentrator off when not in use to prevent oxygen enrichment.
- ⚠ **SMOKING DURING OXYGEN THERAPY IS DANGEROUS** and is likely to result in facial burns or death. **DO NOT** allow smoking within the same room where the oxygen concentrator or any oxygen carrying accessories are located. If you intend to smoke, you must always turn the oxygen concentrator off, remove the cannula and leave the room where the oxygen concentrator is located. If you are unable to leave the room, you must wait at least 10 minutes after you have turned the oxygen concentrator off before smoking.

- ⚠ To ensure you are receiving the therapeutic amount of oxygen according to your medical condition, the Independence must be used only after one or more settings have been individually determined or prescribed by a physician for you at your specific activity levels. The Independence must be used with the specific combination of parts and accessories that were used while your settings were determined.
- ⚠ Replace cannula as recommended by manufacturer. Cannulas may become contaminated with body fluids or expired gases during use.
- ⚠ Use of this device outside of the stated altitude, temperature or humidity ranges is expected to adversely affect the flowrate and the percentage of oxygen and, consequently, the quality of oxygen therapy.
- ⚠ Consult your healthcare provider if you are feeling unwell, which may indicate either too much or too little oxygen.
- ⚠ If you feel discomfort or are experiencing a medical emergency while undergoing oxygen therapy, seek medical assistance immediately to avoid harm.

Battery and Power Supply Safety Guidelines

- ❗ Use of non-approved battery or power supply may cause serious damage to the device and will void the warranty.
- ❗ Use of an unauthorized AC or DC power supply or power supply cable could result in increased electromagnetic emissions or decreased electromagnetic immunity of the equipment and result in improper operation.
- ❗ Store the battery in a cool dry place when not in use to enhance battery life.
- ❗ Remove the battery from the device if it will not be used for an extended period of time.
- ❗ Locate the external power supply in the open air to prevent overheating when in use.
- ❗ U.S. Department of Transportation (DOT) and United Nations (UN) regulations require that batteries be removed from the device when checked as luggage on international flights.
- ❗ The battery may explode if exposed to or disposed of in a fire.
- ❗ Use only the supplied battery, AC and/or DC power supplies that were provided with the device.
- ❗ Keep the battery away from children to prevent injury.
- ❗ DO NOT drive over, drag or place objects on the power cords to avoid damage.
- ❗ Use of a damaged battery or power supply may cause personal injury.

- ⚠ Use of a frayed or damaged AC or DC power supply cable may compromise basic safety with regard to the electromagnetic disturbances over the expected service life.
- ⚠ **DO NOT** attempt to disassemble the battery or power supply. Doing so will void the warranty and may cause personal injury.
- ⚠ **DO NOT** short circuit the battery's metal contacts with metallic objects such as keys or coins. It may cause electric shock, sparks or excessive heat.
- ⚠ **DO NOT** use the battery or power supply for anything other than its intended purpose. Doing so may damage the device or cause personal injury.
- ⚠ **DO NOT** drop the battery or expose it to mechanical shock. If battery is damaged, discontinue use and dispose of properly to avoid personal injury.
- ⚠ **DO NOT** expose the battery to water or other liquids. If battery gets wet, discontinue use and dispose of properly to avoid personal injury.
- ⚠ **DO NOT** expose the battery to excessive heat or cold outside of specifications as it may affect performance.
- ⚠ Use caution when handling the DC plug adapter. This plug may get hot with use. Ensure DC plug socket is clean of debris which may cause overheating.

Section 3: Product Description

Device and Accessories

- ❗ The use of certain humidifiers and administration accessories not specified for use with this oxygen concentrator may impair performance.
- ❗ Your physician, healthcare provider or authorized dealer will recommend the proper cannula for your use. Ensure that selected cannula is compliant to ISO 80601-2-69 Medical Electrical Equipment, Particular requirement for basic safety and essential performance of oxygen concentrator equipment.
- ❗ The configuration of the equipment and accessories must be determined for each individual patient.

This manual applies to the following accessories:

- › Battery
- › AC Power Supply
- › DC Power Cord
- › Accessory Bag
- › Cannula (not included)

This manual does not apply to the following accessory items sold separately:

- › Battery Shell/Blank
- › Desktop Battery Charger, Single Bay
- › Desktop Battery Charger, Dual Bay

Feature Identification

1. Control Panel
2. LCD Display
3. Oxygen Outlet Port
4. Exhaust Vent
5. Wheels
6. Rechargeable Battery Slots
7. FAA Approval Identification
8. Pull Handle
9. Air Intake Vent Filter
10. External Power Input
11. Handle Lock/Release Button
12. Carry Handle

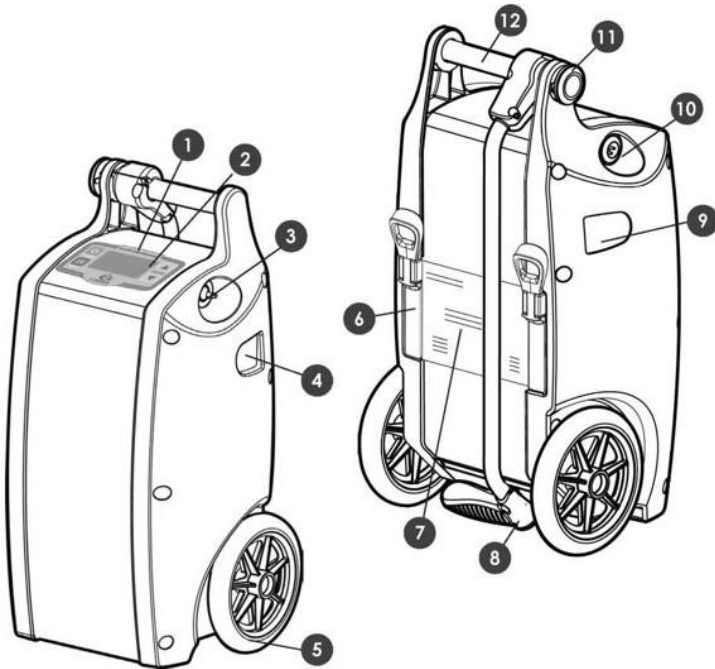

Understanding the Control Panel

13. Power Button
14. Battery Status
15. External Power Source/Battery Charging Indicator
16. Increase/Up Button
17. Decrease/Down Button
18. System Status
19. Breath Detect (Pulse Mode Only)
20. Mode Setting
21. Mode Button
22. Indefinite Acknowledge (Alarm Mute)

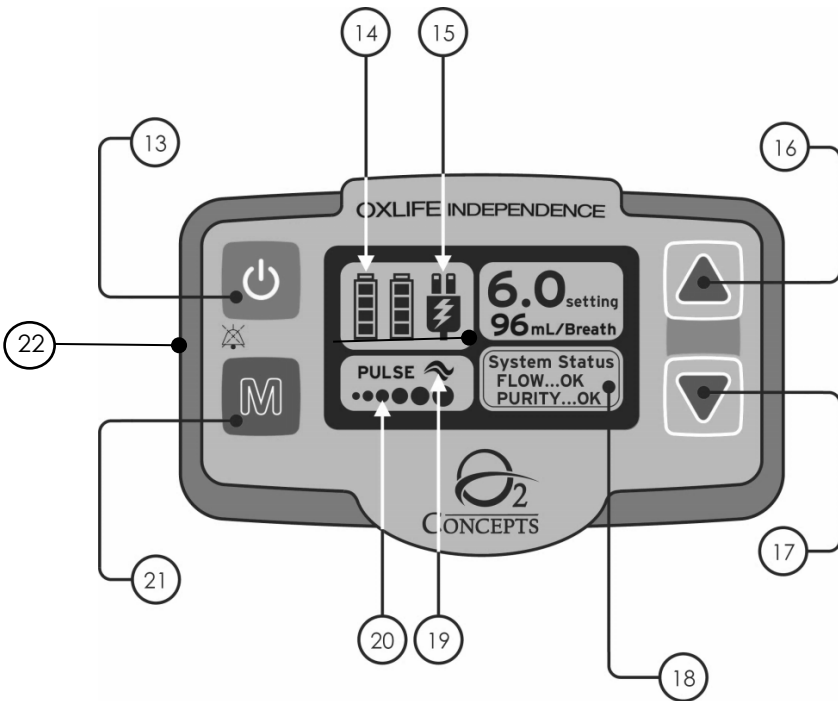

Applied Parts

The applied parts, or components that a patient will come in contact with during normal operation of the device, are listed below:

- › Pull and Carry Handles
- › Control Panel
- › Oxygen Outlet Port
- › External Power Input

Section 4: Operating Instructions

Before Operating

Your authorized dealer has demonstrated the proper operation of your Oxlife Independence®. This manual provides product information and operating instructions and should be saved for future reference to help you safely operate your device. If you have any further questions, contact your authorized dealer or healthcare provider.

This equipment needs to be installed and put into service in accordance with the information provided in the accompanying documents.

DO NOT operate the Independence without first reading the Safety Guidelines included in **SECTION 2** of this manual.

Please follow all operating instructions.

Before each use, ensure that filters are clean and in place and that cannula and power cord connections are intact.

If you are relocating your Independence from an extreme environment, allow the device to return to the specified operating temperature and humidity ranges before use, a minimum of 6 hours.

Operating your device outside of specified ranges may damage your device, impact device performance and may void your warranty.

See Operating Temperature and Humidity Ranges listed in the Specification Table.

Fully charge batteries before first use.

The essential performance of the Oxlife Independence® is to produce $91\% \pm 4\%$ oxygen at continuous settings 0.5-3.0 and pulse settings 0.5-6.0.

Locating Your Device

Place the Independence in a well-ventilated area free of smoke, fumes, pollutants, and away from direct sun light. Avoid high humidity environments.

Ensure that air intake and exhaust ports are not obstructed, and air intake vent filters are in place.

Proper placement and positioning of the device is critical to the effectiveness of the oxygen therapy.

The Independence **MUST** be located so that alarms can be heard.

Position the oxygen supply tubing and power cords in a manner that prevents kinking, air flow obstructions, and tripping hazards.

To protect device finish, it is recommended to use the Independence in either an upright position or lying on its back.

DO NOT operate the device in an enclosed space, such as a closet.

DO NOT locate the Independence near any flammable materials or cleaning product or in the direct path of any heat source such as a stove, heat register or a car heater. Keep the Independence at least 5 feet (1.6m) from hot sparking objects or open flame.

Device Settings

Turn the device on by pressing the Power Button .

Press the Mode Button  to select Continuous or Pulse Flow Mode.

Press the Increase  or Decrease  buttons to select the correct flow rate.

Turn the device off by pressing and holding the Power Button .

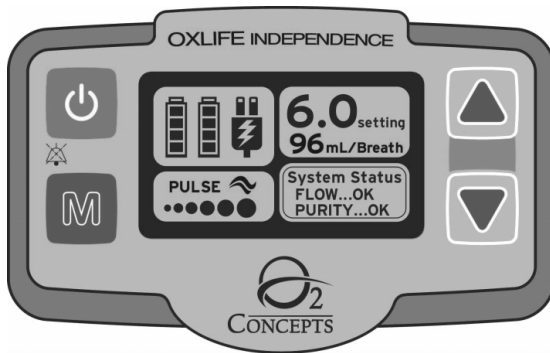

The device may take up to three (3) minutes to warm-up and reach desired performance. System Status will show Flow and Purity are OK when warm-up is complete.

THE PROPER FLOW MODE AND FLOW RATE ARE PRESCRIBED BY YOUR PHYSICIAN. DO NOT CHANGE THESE SETTINGS WITHOUT CONSULTING WITH YOUR PHYSICIAN.

PULSE FLOW MODE SHOULD ONLY BE USED UNDER THE DIRECTION OF YOUR PHYSICIAN. APPROPRIATE AND SAFE PULSE MODE SETTINGS MUST ACCOMMODATE THE INDIVIDUAL PATIENT'S LIFESTYLE INCLUDING REST, TRAVEL AND EXERCISE.

DEVICE OXYGEN DELIVERY SETTINGS SHOULD BE PERIODICALLY REASSESSED FOR EFFECTIVENESS OF THE OXYGEN THERAPY.

THE PATIENT IS THE INTENDED OPERATOR.

Consult your healthcare provider if you are feeling unwell which may indicate too much or too little oxygen. These side effects are not immediate or life threatening.



CONTINUOUS FLOW MODE

In Continuous Flow Mode a continuous flow of oxygen will flow through the cannula and into your nose. The oxygen is measured in Liters per Minute or LPM.



PULSE FLOW MODE

In Pulse Flow Mode the device will detect your breath and supply a measured pulse of oxygen or bolus. The breath detect icon will flash on the control panel with each breath.

At higher flow settings, you may notice the motor revving, which is normal and necessary to achieve maximum oxygen output.

| Breaths per Minute | Pulse Mode Bolus Volumes (ml) | | | | | | | | | | | |
|--------------------|-------------------------------|------|------|------|------|------|------|------|------|------|------|------|
| | 0.5 | 1.0 | 1.5 | 2.0 | 2.5 | 3.0 | 3.5 | 4.0 | 4.5 | 5.0 | 5.5 | 6.0 |
| 15 | 8.0 | 16.0 | 24.0 | 32.0 | 40.0 | 48.0 | 56.0 | 64.0 | 72.0 | 80.0 | 88.0 | 96.0 |
| 20 | 8.0 | 16.0 | 24.0 | 32.0 | 40.0 | 48.0 | 56.0 | 64.0 | 72.0 | 80.0 | 88.0 | 96.0 |
| 25 | 6.4 | 12.8 | 19.2 | 25.6 | 32.0 | 38.4 | 44.8 | 51.2 | 57.6 | 64.0 | 70.4 | 76.8 |
| 30 | 5.3 | 10.7 | 16.0 | 21.3 | 26.7 | 32.0 | 37.3 | 42.7 | 48.0 | 53.3 | 58.7 | 64.0 |
| 35 | 4.6 | 9.1 | 13.7 | 18.3 | 22.9 | 27.4 | 32.0 | 36.6 | 41.1 | 45.7 | 50.3 | 54.9 |
| 40 | 4.0 | 8.0 | 12.0 | 16.0 | 20.0 | 24.0 | 28.0 | 32.0 | 36.0 | 40.0 | 44.0 | 48.0 |

If no breath is detected for 45 seconds, the display screen will turn amber, and the device will beep once. If no breath is detected for an additional 15 seconds, the device will default to the previous continuous flow mode setting.

- ⚠ Respiratory efforts of the patient may not trigger a bolus.
- ⚠ The settings of the Independence might not correspond with continuous flow oxygen.
- ⚠ The settings of other models or brands of oxygen therapy equipment do not correspond with the settings of the Independence.

Installing and Removing the Battery

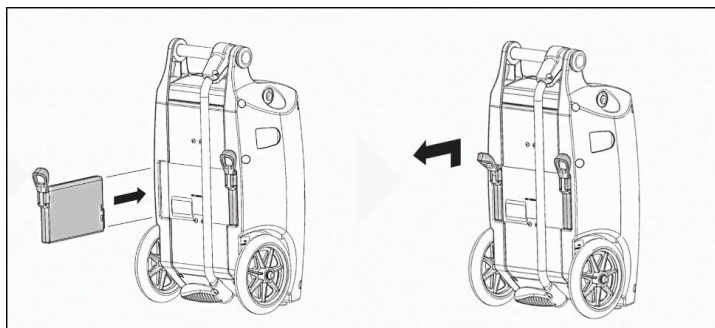

| INSTALL | REMOVE |
|--|--|
| SLIDE INTO BACK OF DEVICE AND PRESS TO ENGAGE; BATTERY WILL DROP DOWN SLIGHTLY AND CLICK INTO POSITION | PULL TAB OUT SLIGHTLY TO RELEASE IT FROM THE BAY; PULL UP AND OUT ON TAB AND THEN SLIDE STRAIGHT OUT |

Typical Battery Operation Times

| FLOW RATE SETTING | CONTINUOUS FLOW (Hours of Battery Life) | | PULSE FLOW (Hours of Battery Life) | |
|-------------------|---|-------------|---------------------------------------|-------------|
| | 1 Battery | 2 Batteries | 1 Battery | 2 Batteries |
| 0.5 | 2 hr 53 min | 5 hr 45 min | 3 hr 8 min | 6 hr 15 min |
| 1.0 | 2 hr 38 min | 5 hr 15 min | 3 hr | 6 hr |
| 1.5 | 1 hr 45 min | 3 hr 30 min | 3 hr | 6 hr |
| 2.0 | 1 hr 15 min | 2 hr 30 min | 2 hr 53 min | 5 hr 45 min |
| 2.5 | 1 hr | 2 hr | 2 hr 23 min | 4 hr 45 min |
| 3.0 | 45 min | 1 hr 30 min | 2 hr | 4 hr |
| 3.5 | <i>Times shown are based upon 20 breaths a minute</i> | | 1 hr 45 min | 3 hr 30 min |
| 4.0 | | | 1 hr 30 min | 3 hr |
| 4.5 | | | 1 hr 15 min | 2 hr 30 min |
| 5.0 | | | 1 hr 8 min | 2 hr 15 min |
| 5.5 | | | 1 hr | 2 hr |
| 6.0 | | | 53 min | 1 hr 45 min |

Battery operating times are based on a new, fully charged battery.

Battery operating time will degrade with battery age, number of charge cycles and operating environment.

Battery Time Management

The Independence comes equipped with a rechargeable lithium ion battery that is **NOT** user serviceable.

The batteries utilized will degrade over time and from standard use; provided, however, the rate of such degradation is dependent upon the frequency of operation of the device solely with battery power as well as frequency and length of associated battery charging cycles.

The manufacturer recommends that the user regularly monitor battery performance by viewing the battery charge level indicator on the battery and the device display. Batteries should be replaced every two years.

With the combined use of the battery, AC power supply, and DC power cord you may extend your time away from home. Using the AC and DC power cords whenever possible will improve battery life. The battery will charge in the device, when plugged into an external power source.

Battery Charge Status is also displayed on the control panel. Each bar represents approximately 25% of the total battery charge. When the battery is fully charged (over 90%) the battery icon will appear solid.

The Independence battery includes a battery charge status indicator located on the front of the battery. Simply press the "PUSH" button on battery to display the remaining battery life in 25% increments.

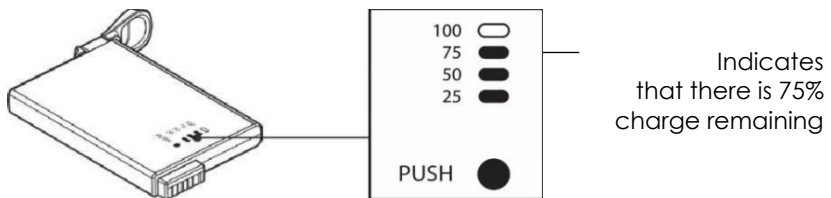

The typical time to recharge a fully discharged battery is approximately 1.5 hours if charging a single battery and 2.5 hours if charging two with the device plugged into the AC power supply and powered off. Battery charge times while the device is running will vary depending on elected setting.

To maximize battery life:

- › Store battery in a cool, dry place when not in use. Store battery with at least 50% capacity remaining.

- › If using multiple batteries, uniquely label each battery to ensure each battery is rotated equally.

- › Charge batteries every three (3) months when not in use.

There is no routine maintenance or service required for the Oxlife Independence® rechargeable batteries other than the periodic replacement as described above.

AC Power Supply

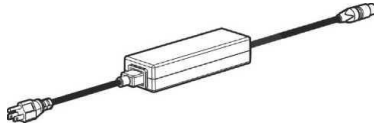

- ❗ Use only the AC power supply (800-1022) provided with this device. Use of power cords not supplied by O2 Concepts may cause overheating or damage to the device and will void the warranty.
- ❗ The power supply is not water resistant.
- ❗ **DO NOT** place anything in the power supply port other than the supplied AC or DC power cords.
- ❗ Ensure the power supply is in a well-ventilated area. The power supply may become hot during operation. Allow the power supply to cool before handling.

The AC power supply consists of the following components:

- › Power supply with attached power supply cable to connect to the device
- › AC power input cable

When powered on, the green LED on the power supply will be illuminated.

The AC power supply charges the battery using a 100-240V 50/60 Hz outlet (a typical wall outlet in your home). Using the AC power supply allows you to use your Independence while simultaneously charging the battery.

To use the AC power supply, connect the power cord to the AC power converter (brick). Then connect the power supply to a wall outlet and the Independence. The external power icon will be displayed on the control panel.

The AC power supply will charge the battery at all settings.

Recommendation for Use:

Use no electrical outlets controlled by a switch.

When changing power sources wait for the control panel to display the new power icon and unit to beep before removing the original source.

The detachable power supply cord to the power supply is the means of isolating the unit from the supply mains.

If the AC power supply is removed from the device, wait 10 seconds before re- applying power.

When traveling internationally a standard international power plug adapter is all that is required.

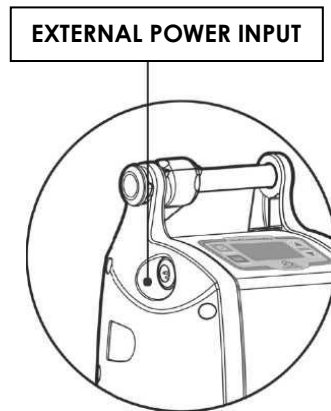

DC Power Supply



The DC power supply allows a patient to operate the Independence from a vehicle's 12/15-volt DC outlet in all settings while the vehicle is running. A 12-volt, 15-amp outlet is recommended for use with the device. DC power is not sufficient to charge batteries at all settings; charging will not occur at settings higher than continuous flow 2.0 or pulse mode 4.0. The external power source icon will be displayed on the control panel.

Each vehicle's DC power outlet varies in specifications and performance. Moreover, such performance may be adversely impacted by one or more applications simultaneously drawing DC power (e.g., cell phones, media players, other electrical systems in the vehicle). In addition, DC power may fluctuate more significantly in stop and go driving conditions.

If a vehicle's DC voltage drops to 11.6 volts or below, the device will alert and revert to battery power. In this condition, the device performance should be monitored; reducing the flow setting may improve the performance of the DC power outlet. If a vehicle's DC voltage drops below 10.6 volts, the device will alarm, and if battery power is not sufficient, the device will shut down.

- ❗ Use only the DC power supply (800-1001) provided with this device. Use of power cords not supplied by O2 Concepts may cause overheating or damage to the device and will void the warranty.
- ❗ Use the DC outlet closest to the battery.

- ⓘ Use no other DC outlets in the vehicle while your Independence is in use.

Recommendations for Use:

When operating the Independence in your vehicle, ensure that the device is securely stowed and will not get damaged during transport.

Ensure that air inlet and exhaust ports are not blocked.

Batteries will not charge at any setting if the engine is not running.

The device may “rev” more while operating on DC power. This is normal operation while connected to DC power and not cause for concern.

DO NOT leave the device plugged into the vehicle when the engine is not running.

DO NOT use the Independence with any power splitting devices.

DC Power Supply User Information Guide

Starting the device on DC power

1. **ALWAYS** have the vehicle's engine running **BEFORE** plugging in your Independence.
2. Plug DC power cord into the device **BEFORE** plugging into the vehicle's DC outlet.
3. Plug DC power cord into the vehicle's DC outlet.
4. Remove the DC power cord from the vehicle's DC outlet when the engine is not running.

Disconnecting the device from DC power

1. **WITHOUT** batteries installed, keep the vehicle's engine running and power the device Off by pressing and holding the power button.
2. When the device is OFF, disconnect the DC power cord from the vehicle's DC outlet.
3. **WITH** batteries installed, disconnect the DC power cord from device. The device will beep once and switch to internal battery power.

Reset/Reboot

1. **WITH** batteries installed, remove DC power from the device and wait 15 seconds.
2. Remove the batteries from the device.
3. Re-insert the DC power cord into the device.
4. Turn device ON using the power button.

DC Power Supply Troubleshooting Guide

| <u>Event</u> | <u>Solution</u> |
|--|---|
| Batteries Not Charging | <ul style="list-style-type: none"> • If there is no charging icon (lightning bolt symbol), reduce the device setting to 0.5LPM Continuous and wait for charging icon to appear. • Next, increase the flow rate by 0.5 increments until desired flow rate is reached. (Batteries will not charge on settings higher than 2.0 Continuous or 4.0 Pulse) |
| Low Battery Alarm | <ul style="list-style-type: none"> • If batteries are fully depleted to 0%, they may not charge until the device is powered off. Batteries may require being charged to 10% in order for the lightning bolt to appear on the display. • To prevent accidental discharge of fully charged batteries, batteries can be removed from the device while running on DC power. |
| Device Alerting / Beeping Intermittently | <ul style="list-style-type: none"> • If the DC power drops equal to or below 11.6 volts, the device will beep. • If batteries are installed, the device will switch to battery power. • The device will automatically return to DC power once the vehicle supplies the proper voltage. The device will default to the most reliable source of power to supply oxygen. |
| Low External Power Alarm | <ul style="list-style-type: none"> • There may be too much of a power draw on the vehicles electrical system (air conditioning, radio, or GPS). Try eliminating these power draws. • Check your vehicle's user manual or consult an auto technician to determine your vehicle's DC power amperage and wattage. The device requires 150 watts (15 amps) to run at all settings. • You may require an Inverter with at least a 450-watt capacity. This can be purchased through any Auto Service Provider. |

Handle Operation

OPEN/CLOSE

Press button to unlock handle.

Begin rotating and release button.

Handle will re-lock in open/close position automatically.

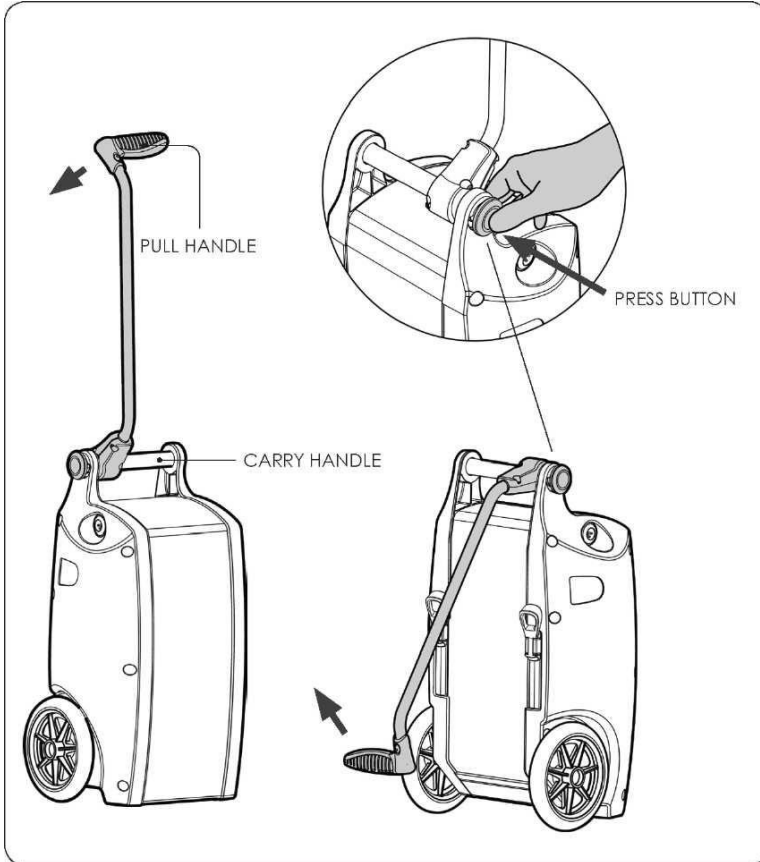

HANDLING

DO NOT LEAN ON UNIT

To prevent damage to the unit, avoid resting excessive weight on handle.



STAIRS

While transporting the unit down stairs, it is recommended to allow unit to travel down first.



Accessory Bag

The Accessory Bag is designed to carry your Independence accessories including batteries, AC charger and cable, and DC charger.

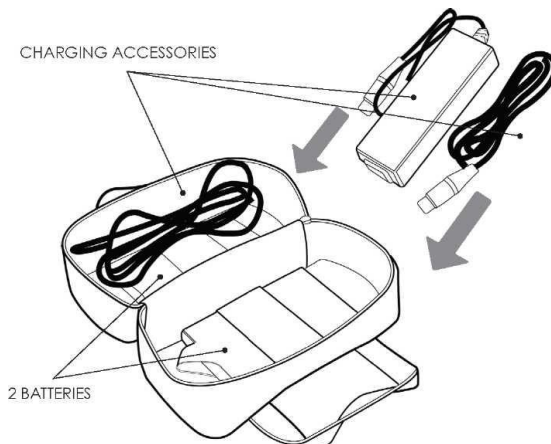

Cannula Use

- ⚠️ Your physician, healthcare provider or authorized dealer will recommend the proper cannula for your use.
- ⚠️ Ensure selected cannula is compliant to *ISO 80601-2-69 Medical Electrical Equipment, particular requirement for basic safety and essential performance of oxygen concentrator equipment.*
- ⚠️ Use of a cannula not specified for use with oxygen may impair the performance of your device.
- ⚠️ **DO NOT** use cannula tubing longer than 7 feet in Pulse Flow Mode.
- ⚠️ **DO NOT** use cannula tubing longer than 50 feet in Continuous Flow Mode.
- ⚠️ A single lumen nasal cannula rated for 6 liters per minute is required to ensure proper oxygen delivery.
- ⚠️ To ensure proper oxygen flow, confirm that the cannula is not pinched or blocked in any way.
- ⚠️ The cannula fitting may be tight.
- ⚠️ **DO NOT** use grease or oils to lubricate the oxygen outlet port.



Read and follow the instructions included with the cannula and provided by your authorized dealer.

Regularly clean and replace your cannula as instructed by the manufacturer and authorized dealer or healthcare provider.

O2 Concepts recommends the following cannulas by Salter Labs:

- › 7ft (2.13m) cannula: Part #16SOFT-7, or equivalent.
- › 50ft (15.25m) cannula: Part #OTC-203-50, or equivalent.

Accessing the Provider Screen and Changing Languages

The Provider Screen shows information about the status and language setting of the unit. Within the Provider Screen, the language of the device can be changed to six different languages, including English, German, Dutch, Spanish, French, and Italian.

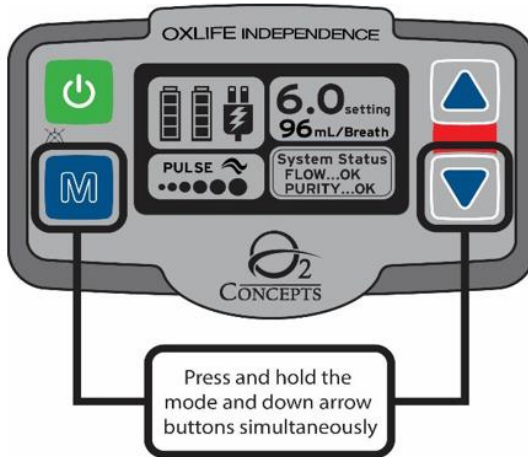

Entering the Provider Screen:

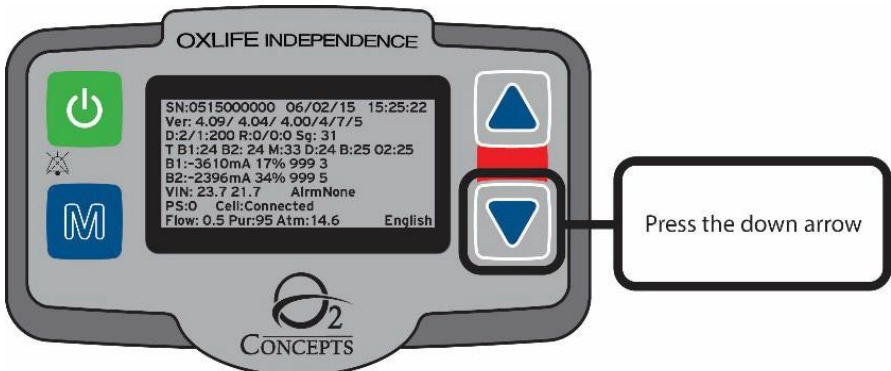

Press and hold the Mode Button  and Down Arrow Button  simultaneously to enter the Provider Screen.

Changing Languages:



Inside the Provider Screen, the user can change the device language by pressing the Down Arrow Button . The current language is displayed in the bottom right corner. The language changes each time the Down Arrow Button  is pressed in the order shown below.

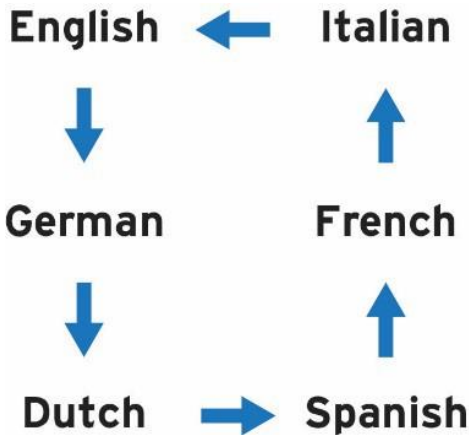

Cell Status and Signal Strength:

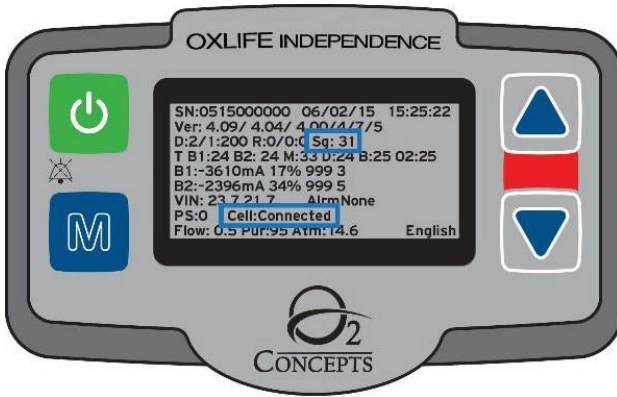

The cell signal strength is listed in the third row on a scale of 0 through 31 (ex. Sq:31). The cell status is listed in the eighth row (ex. Cell: Connected).

Voltage In:

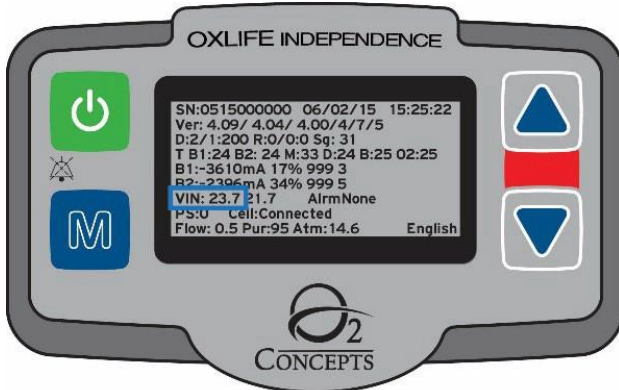

The voltage in is the voltage that the unit is receiving from an external power source, such as the AC power supply or DC power supply (ex. VIN: 23.7 where 23.7 is in volts).

Section 5: User Alerts and Alarms

The functionality of the alarm system is verified automatically by the unit upon start up by the unit flashing the three (3) visual display colors and audible indicators. There are delays that are greater than ten (10) seconds inherent to specific alarms, and these delays are explained in detail for each alarm in the tables below.

Alarm and Alert Screens

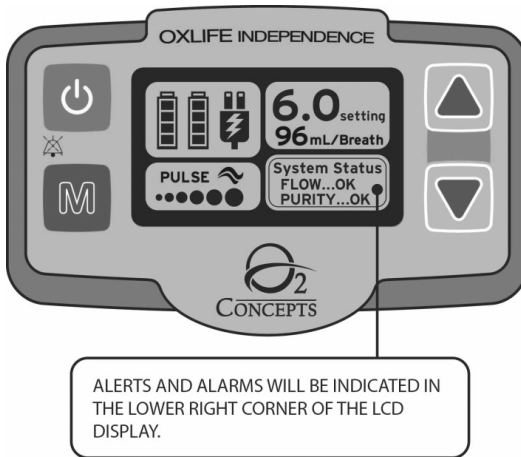



Indefinite Acknowledge (Alarm Mute)



In an alert or alarm condition, pressing the power button will put the device into indefinite acknowledge state or alarm mute. In this state, the alarm will be silenced, and the screen will stop flashing. The device will stay in this state until powered off or until a higher-priority alarm is activated.



Alarm and Alert Screen Descriptions

Alarms

The LCD screen will be RED in Alarm Mode

| | |
|---|--|
| <p>Low Purity Alarm (technical) (high priority)</p> | <p>When oxygen levels drop below 72% for 60 seconds, the screen will flash red at 2Hz, sound a 10-beep sequence repeated after 2.5 seconds of silence and the text "Low Purity" will flash in the system status window.</p> <p>The device will continue to sound until the power  button is pressed to silence the audio; the power button is held to power off the unit or 15 seconds has expired at which time the device will power off.</p> |
| <p>Solutions:</p> | <p>Clean or replace air inlet filter. Repair or replace tubing. Change to another source of oxygen and contact your authorized dealer.</p> |
| <p>No Flow Alarm (technical) (high priority)</p> | <p>When the flow of oxygen is stopped for 45 seconds, the screen will flash red at 2Hz, sound a 10-beep sequence repeated after 2.5 seconds of silence and the text "No Flow" will flash in the system status window.</p> <p>The device will continue to sound until the power  button is pressed to silence the audio; the power button is held to power off the unit or 15 seconds has expired at which time the device will power off.</p> |
| <p>Solutions:</p> | <p>Check cannula connection. Repair or replace tubing. Clean or replace air inlet filter. Move device to ensure adequate air flow. Change to another source of oxygen and contact your authorized dealer.</p> |
| <p>Low Battery Alarm (technical) (high priority)</p> | <p>When battery power is depleted, the pump shuts off, the screen will flash red at 2Hz, sound a 10-beep sequence repeated after 2.5 seconds of silence and the text "Low Battery" will flash in the system status window. The device will continue to sound until the power  button is pressed to silence the audio; the power button is held to power off the device or 15 seconds has expired at which time the device will power off.</p> |

| | |
|---|--|
| Solutions: | Plug into an external power source. Replace depleted battery (batteries) with a charged battery. |
| High External Power Alarm (technical) (high priority) | <p>When the voltage from an external power source is above 26 volts (as measured by the device internally), the screen will flash red at 2Hz, sound a 10-beep sequence repeated after 2.5 seconds of silence and the text "High External Power" will flash in the system status window.</p> <p>The device will continue to sound until the power  button is pressed to silence the audio; the power button is held to power off the device or 15 seconds has expired at which time the device will power off.</p> |
| Solutions: | Connect to an authorized O2 Concepts Independence power supply. |
| Low External Power Alarm (technical) (high priority) | <p>When the voltage from an external power source falls below 10.6 volts (as measured by the device internally), the screen will flash red at 2Hz, sound a 10-beep sequence repeated after 2.5 seconds of silence and the text "Low External Power" will flash in the system status window.</p> <p>The device will continue to sound until the power  button is pressed to silence the audio; the power button is held to power off the device or 15 seconds has expired at which time the device will power off.</p> |
| Solutions: | <p>Ensure all charging connections are intact. Refer to the DC user guide section of this manual.</p> <p>Change to another source of power and contact your authorized dealer.</p> |
| Unauthorized Battery Alarm (technical) (high priority) | If the device detects that a battery other than one from O2 Concepts has been installed in the device, the battery icon will show an exclamation point within the battery outline. If no other power source is present, the screen will flash red at 2Hz, sound a 10-beep sequence repeated after 2.5 seconds of silence and the text "Unauthorized Battery" will flash in the system status window. |



| | |
|--|--|
| | The device will continue to sound until the power  button is pressed to silence the audio; the power button is held to power off the device or 15 seconds has expired at which time the device will power off. |
| Solutions: | Remove unauthorized battery and replace with an authorized O2 Concepts Independence battery. |
| Over Temperature Alarm (technical) (high priority) | The maximum operating temperature of the enclosure and pump is 70°C and 90°C respectively. If either of these component temperatures are reached for 15 seconds, the screen will flash red at 2Hz, sound a 10-beep sequence repeated after 2.5 seconds of silence and the text "Over Temperature" will flash in the system status window. The device will continue to sound until the power  button is pressed to silence the audio; the power button is held to power off the device or 15 seconds has expired at which time the device will power off. |
| Solutions: | Relocate the device to improve airflow or to a cooler environment and allow the device to reach operating temperature. Utilize an alternate source of oxygen if necessary and contact your authorized dealer. |
| Invalid Motor Temperature Alarm (technical) (high priority) | When the motor temperature is out of a valid range for 15 seconds, the screen will flash red at 2Hz, sound a 10-beep sequence repeated after 2.5 seconds of silence and the text "Invalid Motor Temperature" will flash in the system status window. The device will continue to sound until the power  button is pressed to silence the audio; the power button is held to power off the device or 15 seconds has expired at which time the device will power off. |
| Solutions: | Relocate the device to improve airflow or to a cooler environment and allow the device to reach operating temperature. Utilize an alternate source of oxygen if necessary and contact your authorized dealer. |

| | |
|---|---|
| <p>Invalid Box Temperature Alarm (technical) (high priority)</p> | <p>When the internal box temperature is out of a valid range for 15 seconds, the screen will flash red at 2Hz, sound a 10-beep sequence repeated after 2.5 seconds of silence and the text "Invalid Box Temperature" will flash in the system status window.</p> <p>The device will continue to sound until the power  button is pressed to silence the audio; the power button is held to power off the device or 15 seconds has expired at which time the device will power off.</p> |
| <p>Solutions:</p> | <p>Relocate the device to improve airflow or to a cooler environment and allow the device to reach operating temperature.</p> <p>Utilize an alternate source of oxygen if necessary and contact your authorized dealer.</p> |
| <p>No External Power Alarm (technical) (high priority)</p> | <p>If power is removed while the device is running it will sound a 10-beep sequence after 4 seconds of silence at which time the device will power off.</p> <p>Since the power is removed, the display is blank, and no backlight color is available.</p> |
| <p>Solutions:</p> | <p>Ensure all charging connections are intact. In the case of an extended outage, utilize an alternate, non-powered source of oxygen.</p> |

DO NOT IGNORE ALERTS OR ALARMS

Alerts

The LCD screen will be AMBER in Alert Mode

| | |
|--|---|
| <p>Low Purity Alert (technical) (low priority)</p> | <p>When oxygen levels drop below 85% for 60 seconds, the screen will turn amber, sound one beep every 30 seconds and the text "Low Purity" will flash in the system status window. Pushing the power  button once silences the alert.</p> |
| <p>Solutions:</p> | <p>Clean or replace air inlet filter. Contact your authorized dealer.</p> |
| <p>Low Battery Alert (technical) (low priority)</p> | <p>When calculated battery run time reaches 6 minutes remaining, the screen will turn amber, sound one beep every 30 seconds and the text "Low Battery" will flash in the system status window. Pushing the power  button once silences the alert.</p> |
| <p>Solutions:</p> | <p>Connect to an external power source. Replace depleted battery (batteries) with a charged battery.</p> |
| <p>Unauthorized Battery Alert (technical) (medium priority)</p> | <p>If the device detects that a battery other than one from O2 Concepts has been installed in the device, the battery icon will show an exclamation point within the battery outline. The device will continue to run if on AC, DC, or a second valid battery is present. The screen will turn amber, sound a 3-beep sequence repeated after 15 seconds of silence and the text "Unauthorized Battery" will flash in the system status window. Pushing the power  button once silences the alert.</p> |
| <p>Solutions:</p> | <p>Remove unauthorized battery and replace with an authorized O2 Concepts Independence battery.</p> |

| | |
|--|---|
| <p>Low External Power Alert (technical) (medium priority)</p> | <p>When the voltage from an external power source falls to 11.6 volts or less (as measured by the device internally) for 3 seconds, the screen will turn amber, sound a 3- beep sequence repeated after 15 seconds of silence and the text "Low External Power" will flash in the system status window. Pushing the power  button once silences the alert.</p> |
| <p>Solutions:</p> | <p>Ensure all charging connections are intact. Refer to the DC user guide section of this manual. Change to another source of power and contact your authorized dealer.</p> |
| <p>No Breath Alert (physiological) (low priority)</p> | <p>When in Pulse mode, if a breath is not detected for 45 seconds, the screen will turn amber, sound one beep and the text "No Breath" will flash in the system status window. If no breath is detected for an additional 15 seconds, the unit will switch to the previous CONTINUOUS mode setting selected. Note: No Breath Alarm is used when in Pulse Mode ONLY.</p> |
| <p>Solutions:</p> | <p>Check the cannula for kinks or obstructions. Ensure patient is breathing through their nose. Ensure cannula tubing does not exceed 7 feet (2.1m).</p> |

DO NOT IGNORE ALERTS OR ALARMS

Alarm System Test

Use this test to verify that the alarm system is working properly. This test includes screen color, screen flashing sequence, and audible alarm sequence. Follow the steps in the procedure listed below.

Step 1:

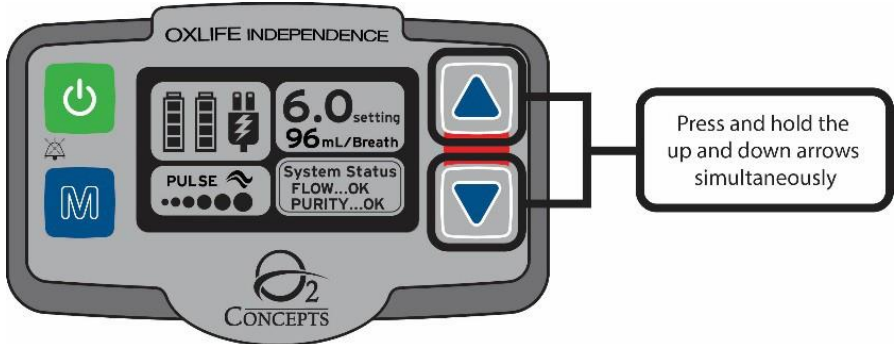

Press and hold both the Up-Arrow Button ▲ and Down Arrow Button ▼ simultaneously in order to enter the Service Mode screen.

Step 2:

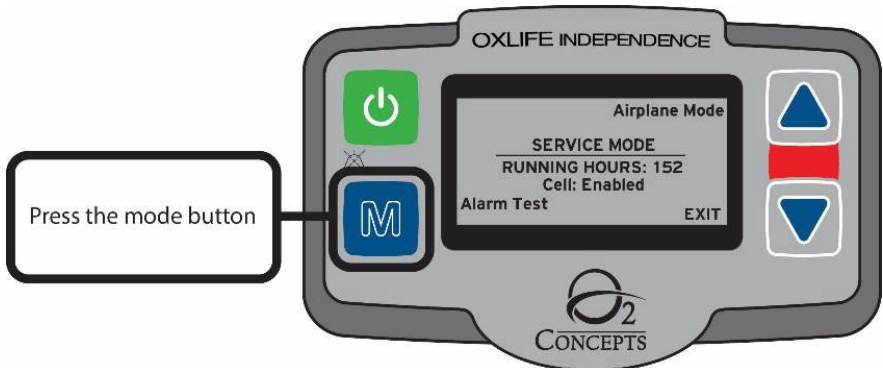

Press the Mode Button  to test the alarm system.

Step 3:

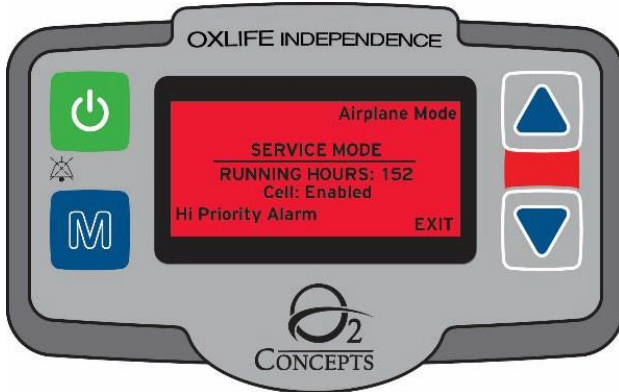

The system will begin by testing the High Priority Alarm. The High Priority Alarm consists of a 10-beep sequence separated by 2.5 seconds of silence, and the LCD screen flashes red.

Step 4:

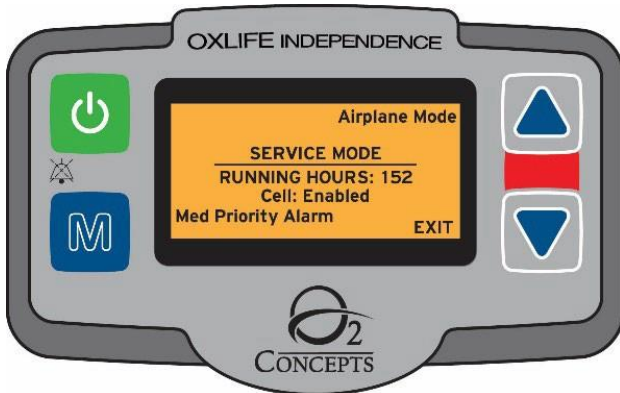

The unit will automatically enter the Medium Priority Alarm test once the High Priority Alarm sequence has concluded. Pressing the Mode Button  while the High Priority Alarm test is in progress will terminate the High Priority Alarm test and start the Medium Priority Alarm. The Medium Priority Alarm consists of a 3-beep sequence separated by 15 seconds of silence, and the LCD screen will flash amber.

Step 5:

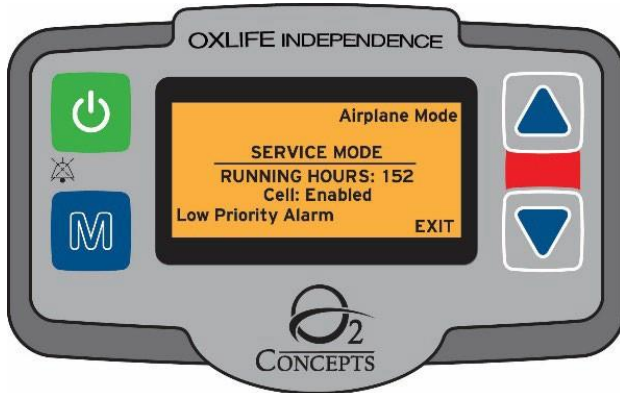

The unit will automatically enter the Low Priority Alarm test once the Medium Priority Alarm sequence has concluded. Pressing the Mode Button  while the Medium Priority Alarm test is in progress will terminate the Medium Priority Alarm test and start the Low Priority Alarm. The Low Priority Alarm consists of 1 beep and a solid amber LCD screen.

Step 6:

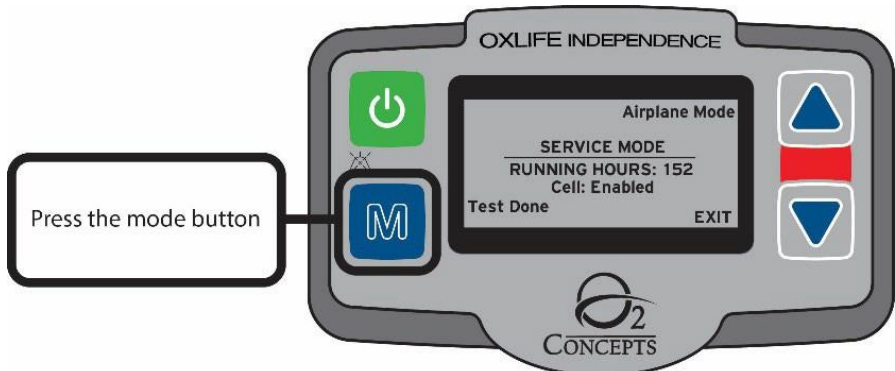

The screen will display Test Done after the Alarm System Test has concluded. Press the Mode Button  once to reset and complete the Alarm Test feature.

Step 7:

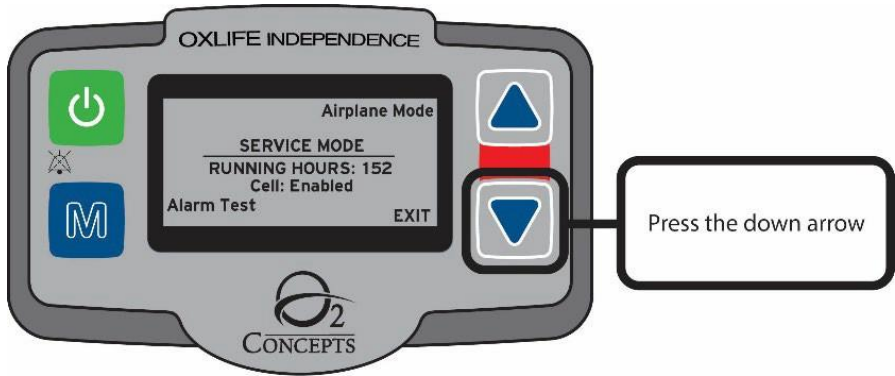

Press the Down Arrow Button  in order to exit the Service Mode screen.

Section 6: Maintenance and Cleaning

Maintenance

Routine cleaning of the air inlet filter, and the device care and cleaning, as described below, are the only routine maintenance by the user necessary for the operation of the Independence.

There is no routine maintenance or service to the O2 Concepts rechargeable batteries other than periodic replacement as described in the section on Battery Time Management, page 32.

All other maintenance or service **MUST** be conducted by a qualified Oxlife Independence® service technician. **DO NOT** attempt to disassemble or perform any maintenance on your device. Any such attempt will void the warranty.

Pre-Use Functional Check

A trained service technician can qualitatively verify that the device is ready for use by performing the following protocols:

- › Connect the nasal cannula to the cannula port on the device. Set the device to continuous flow mode. The technician should be able to hear the flow of oxygen by placing the outlet of the nasal cannula near his or her ear (do not direct flow straight at ear to avoid discomfort).
- › The technician should be able to feel the flow of oxygen by placing a finger rough a half inch from the outlet of the nasal cannula.
- › Place the end of the nasal cannula in a half-full cup of water. Verify that there are bubbles from the output of the nasal cannula.

Device Care and Cleaning

Air Inlet Filter Cleaning

Routine cleaning of the air inlet filter as described below and periodic cleaning of the exterior of the device is the only routine maintenance.

To keep your Independence working properly, it is recommended you clean the air inlet filter weekly. If the Independence is used in a dusty environment, more frequent cleaning of the air inlet filter may be required.

Follow these simple directions to clean the air inlet filter:

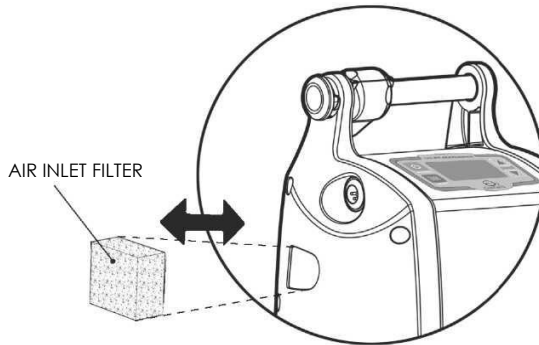

1. Remove the air inlet filter.
2. Wash the filter by running under warm tap water using a mild detergent.
3. Rinse thoroughly under warm, running water.
4. Squeeze out excess water.
5. It is important to allow the filter to dry completely before reinserting into the device. Moisture from a wet or damp air inlet filter may damage your device.

- ⚠ Never use your Independence without an air inlet filter.
- ⚠ We recommend that you keep an extra air inlet filter to use as a replacement while one is drying. Contact your authorized dealer for extra air inlet filters.

Cleaning

- ⚠ Unplug your Independence before cleaning.
- ⚠ Do not submerge your device or any accessories or allow water to enter the device.

Clean the exterior of your device using a soft cloth dampened with a mild detergent and water and wipe dry. Clean the outside of the device monthly or more frequently, as needed.

- ⚠ **DO NOT** spray or soak the case or front panel.
- ⚠ **DO NOT** use alcohol, ethylene chloride or petroleum-based cleaners on the case or power supplies.

AC and DC Power Supplies and Cords

- ⚠ Unplug your Independence and/or power supply before cleaning.

Clean the power supplies and cords using a soft cloth dampened with a mild detergent and water and wipe dry.

Disinfection

Between patients, the exterior of the device and battery should be disinfected.

Clean the device as instructed above.

Per manufacturer's instructions, disinfect exterior and battery using Oxycide with a soft cloth.

Use of a cleaning product containing benzalkonium chloride may impact material durability.

Battery Disposal

This product may contain substances that could be harmful to the environment if inappropriately disposed of in landfills. Follow local governing ordinances and recycling plans regarding disposal of the device.

Device Disposal

This product may contain substances that could be harmful to the environment if disposed of in landfills that are inappropriate. Follow local governing ordinances and recycling plans regarding disposal of the device.

Section 7: Traveling

Before traveling, be sure to pack the following:

- › Accessory Bag
- › AC Power Supply
- › DC Power Supply
- › Fully Charged Battery (and extra batteries if required)

Also, bring contact information for your healthcare provider, authorized dealer and/or physician.

When traveling internationally, a standard international power plug adapter is required.

Please note that many air carriers require prior notification (usually at least 48 hours) for passengers traveling with portable oxygen concentrators. In addition, most carriers will also require advanced submission of a medical verification statement from your physician. You should confirm any notification and verification requirement with your specific carrier.

Not all air carriers provide an electrical outlet aboard the aircraft, so you should have sufficient batteries (or confirmed alternative power source) to account for at least 150% of your total travel time, including, but not limited to: (A) commuting time to and from the airport; (B) transition time in and out of airports; (C) the duration of your flight; and (D) any unexpected delays. Please be aware that your battery requirements may vary based upon your personal setting.

If traveling by train, bus or boat contact your carrier to inquire about power port/outlet availability.

Entering and Exiting Airplane Mode

The cellular connection must be deactivated prior to flight on any commercial aircraft.

To enter and exit Airplane Mode, follow the steps listed in the procedure below.

Step 1:

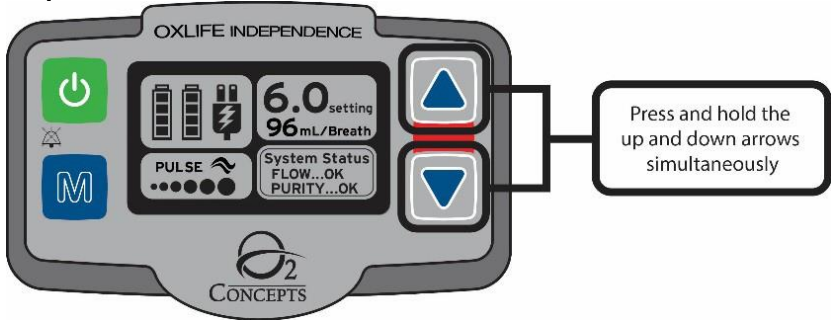

Press and hold both the Up-Arrow Button ▲ and Down Arrow Button ▼ simultaneously in order to enter the Service Mode screen.

Step 2:

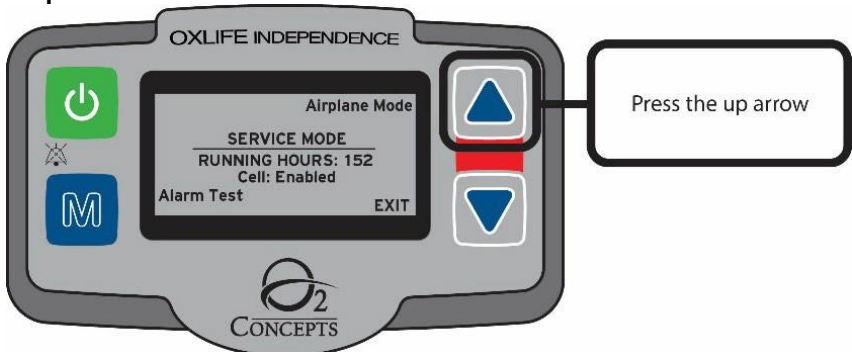

Press the Up-Arrow Button ▲ in order to enter Airplane Mode. The mode listed in the upper right corner of the display is the mode that you will be entering.

Step 3:

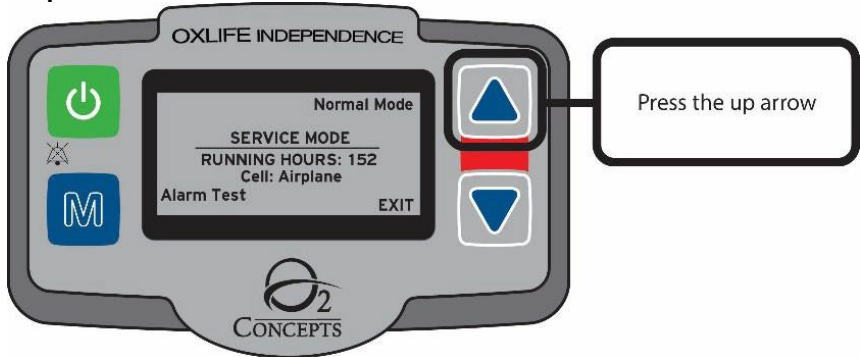

The unit will exit Airplane Mode after 24 hours have passed or the user manually re-enters Normal Mode. Press the Up-Arrow Button ▲ again to enter Normal Mode.

Step 4:

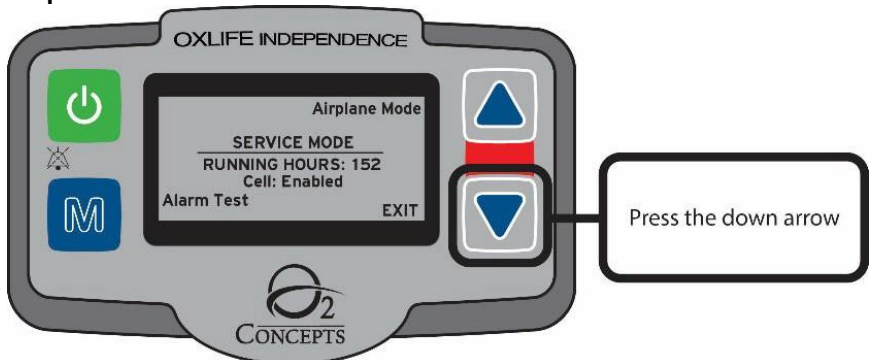

Press the Down Arrow Button ▼ in order to exit the service mode screen.

Section 8: Standards Compliance

This device is designed to comply with the following standards:

IEC 60601-1 2005 Ed.3+A1; Medical Electrical Equipment; Part 1: General Requirements for Basic Safety and Essential Performance

IEC 60601-1-2 4th Edition; Medical Electrical Equipment, Part 1-2: General Requirement for Safety – Collateral Standard: Electromagnetic (EMC) Compatibility

IEC 60601-1-6:2010 Ed3+A1 Medical Electrical Equipment – Part 1-6 General Requirements for Basic Safety and Essential Performance – Collateral Standard: Usability

IEC 60601-1-8:2006 Ed.2 + A1 Medical Electrical Equipment – Part 1-8: General Requirements for Basic Safety and Essential Performance – Collateral Standard: General Requirements Tests and Guidance for Alarm Systems in Medical Electrical Equipment and Medical Electrical Systems

IEC 60601-1-11:2015 Ed.2 Medical Electrical Equipment Part 1-11: General Requirements for Basic Safety and Essential Performance Collateral Standard – Requirements for Medical Electrical Equipment and Medical Electrical Systems Used in the Home Healthcare Environment

IEC 62304:2006 Ed1 + A1 Medical Device Software – Software Life Cycle Processes

AAMI IEC 62366:2007 +A1 Medical Devices – Application of Usability Engineering to Medical Devices (R2013)

ISO 80601-2-67 Issued: 2014/06/01 Ed.1 Medical Electrical Equipment – Part 2-67 Particular Requirements for Basic Safety and Essential Performance of Oxygen Conserving Equipment

ISO 80601-2-69 Issued: 2014/07/15 Ed.1 Medical Electrical Equipment – Part 2-69 Particular Requirements for Basic Safety and Essential Performance of Oxygen Concentrator Equipment

RTCA, DO 160, Section 21, Category M; Emission of Radio Frequency Energy

ISO 13485:2016 Medical Devices; Quality Management Systems; Requirements for Regulatory Purposes

Classification

The Oxlife Independence® is classified as:

- › IEC Class II Internally Powered Equipment
- › Type BF Applied Part
- › IP22: Drip Proof Equipment (Protected against solid objects over 12 mm and direct sprays of water up to 15° of vertical per IEC 60529)
- › **NOT** suitable for use in the presence of flammable anesthetic mixture with air or with oxygen or nitrous oxide
- › Continuous Operation

Guidance and Manufacturer's Declaration for Electromagnetic Immunity and Recommended Separation Distances between Portable and Mobile RF Communications Equipment and This Device:

The concentrator is intended for use in an environment where the radiated RF disturbances are controlled. Do not use the device near active HF surgical equipment and the RF shielded room of an ME system for magnetic resonance imaging, where the intensity of EM disturbances is high. Electromagnetic interference can be minimized by maintaining the distances described below based on the output of the equipment below.

| Guidance and manufacturer's declaration – electromagnetic emissions | | |
|---|-------------------|---|
| The Oxlife Independence® Portable Oxygen Concentrator is intended for use in the electromagnetic environment specified below. The customer or the user of the Oxlife Independence® Portable Oxygen Concentrator should assure that it is used in such an environment. | | |
| Emissions Test | Compliance | Electromagnetic Environment - Guidance |
| RF Emissions CISPR 11 | Group 1 | The Oxlife Independence® Portable Oxygen Concentrator use RF energy only for its internal function. Therefore, its RF emissions are very low and are not likely to cause any interference in nearby electronic equipment. The Oxlife Independence® Portable Oxygen Concentrator is suitable for use in all establishments, including domestic, and those directly connected to the public low-voltage power supply network that supplies building used for domestic purposes. The Oxlife Independence® Portable Oxygen Concentrator is not suitable for interconnection with other equipment. |
| RF Emissions CISPR 11 | Class B | |
| Harmonics IEC 61000-3-2 | Class A | |
| Flicker IEC 61000-3-3 | Complies | |
| RF Emissions CISPR 14-1 | Complies | |
| RF Emissions CISPR 15 | Complies | |

| Guidance and manufacturer's declaration – electromagnetic immunity | | | |
|--|----------------------------------|----------------------------------|--|
| The Oxlife Independence® Portable Oxygen Concentrator is intended for use in the electromagnetic environment specified below. The customer or the user of the Oxlife Independence Portable Oxygen Concentrator should assure that it is used in such an environment. | | | |
| Immunity Test | IEC 60601 Test Level | Compliance Level | Electromagnetic Environment - Guidance |
| ESD IEC 61000-4-2 | ±8kV Contact ±15kV Air | ±8kV Contact ±15kV Air | Floors should be wood, concrete or ceramic tile. If floors are synthetic, the r/h should be at least 30% |
| EFT IEC 61000-4-4 | ±2kV Mains ±1kV I/Os | ±2kV Mains ±1kV I/Os | Mains power quality should be that of a typical commercial or hospital environment. |
| Surge IEC 61000-4-5 | ±1kV Differential ±2kV Common | ±1kV Differential ±2kV Common | Mains power quality should be that of a typical commercial or hospital environment. |

| | | | |
|---|---|--|--|
| Voltage Dips/Dropout IEC 61000-4-11 | >95% Dip for 0.5 Cycle 60% Dip for 5 Cycles 30% Dip for 25Cycles 0% UT for 1 Cycle >95% Dip for 5 Seconds | >95% Dip for 0.5 Cycle 60% Dip for 5 Cycles 30% Dip for 25 Cycles 0% UT for 1 Cycle Note 1 | Mains power quality should be that of a typical commercial or hospital environment. If the user of the Oxlife Independence® Portable Oxygen Concentrator requires continued operation during power mains interruptions, it is recommended that the Oxlife Independence® Portable Oxygen Concentrator be powered from an uninterruptible power supply or battery. |
| Power Frequency 50/60 Hz Magnetic Field IEC 61000-4-8 | 30A/m | 30A/m | Power frequency magnetic fields should be that of a typical commercial or hospital environment. |

Guidance and manufacturer's declaration – electromagnetic immunity

The Oxlife Independence® Portable Oxygen Concentrator is intended for use in the electromagnetic environment specified below. The customer or the user of the Oxlife Independence® Portable Oxygen Concentrator should assure that it is used in such an environment.

| Immunity Test | IEC 60601 Test Level | Compliance Level | Electromagnetic Environment – Guidance |
|---|---|---------------------------------|--|
| Conducted RF IEC 61000-4-6 Radiated RF IEC 61000-4-3 | 6 Vrms 150kHz to 80MHz 3 V/m 80 MHz to 2.5 GHz | (V1) = 6Vrms (E1) = 3V/m | Portable and mobile communications equipment should be separated from the Oxlife Independence® Portable Oxygen Concentrator by no less than the distances calculated/listed below: $D = (3.5/V1)(\sqrt{P})$ 150kHz to 80MHz $D = (3.5/E1)(\sqrt{P})$ 80 to 800 MHz $D = (7/E1)(\sqrt{P})$ 800 MHz to 2.5 GHz Where P is the max power in watts and D is the recommended separation distance in meters. Field strengths from fixed transmitters, as determined by an electromagnetic site survey, should be less than the compliance levels (V1 and E1). Interference may occur in the vicinity of equipment containing a transmitter. |

| | | | |
|--|---|---|---|
| Proximity fields from RF wireless communications equipment IEC 61000-4-3 | See table below (Test Specification for Enclosure Port Immunity to RF Wireless Communication Equipment) | See table below (Test Specification for Enclosure Port Immunity to RF Wireless Communication Equipment) | See table below (Test Specification for Enclosure Port Immunity to RF Wireless Communication Equipment) |
|--|---|---|---|

| Max Output Power (Watts) | Separation (m) 150kHz to 80MHz $D=(3.5/\sqrt{P})(\text{Sqrt } P)$ | Separation (m) 80 to 800MHz $D=(3.5/E1)(\text{Sqrt } P)$ | Separation (m) 800MHz to 2.5GHz $D=(7/E1)(\text{Sqrt } P)$ |
|--------------------------|---|--|--|
| 0.01 | 0.11667 | 0.11667 | 0.23333 |
| 0.1 | 0.36894 | 0.36894 | 0.73785 |
| 1 | 1.1667 | 1.1667 | 2.3333 |
| 10 | 3.6894 | 3.6894 | 7.3785 |
| 100 | 11.667 | 11.667 | 23.333 |

Test Specification for Enclosure Port Immunity to RF Wireless Communications Equipment

| Test frequency (MHz) | Band ^{a)} (MHz) | Service ^{a)} | Modulation ^{b)} | Maximum power (W) | Distance (m) | IMMUNITY TEST LEVEL (V/m) |
|----------------------|--------------------------|--|---|-------------------|--------------|---------------------------|
| 385 | 380 – 390 | TETRA 400 | Pulse modulation ^{b)} 18 Hz | 1,8 | 0,3 | 27 |
| 450 | 430 – 470 | GMRS 460, FRS 460 | FM ^{c)} ± 5 kHz deviation 1 kHz sine | 2 | 0,3 | 28 |
| 710 | 704 – 787 | LTE Band 13, 17 | Pulse modulation ^{b)} 217 Hz | 0,2 | 0,3 | 9 |
| 745 | | | | | | |
| 780 | | | | | | |
| 810 | 800 – 960 | GSM 800/900, TETRA 800, IDEN 820, CDMA 850, LTE Band 5 | Pulse modulation ^{b)} 18 Hz | 2 | 0,3 | 28 |
| 870 | | | | | | |
| 930 | | | | | | |
| 1 720 | 1 700 – 1 990 | GSM 1800; CDMA 1900; GSM 1900; DECT; LTE Band 1, 3, 4, 25; UMTS | Pulse modulation ^{b)} 217 Hz | 2 | 0,3 | 28 |
| 1 845 | | | | | | |
| 1 970 | | | | | | |
| 2 450 | 2 400 – 2 570 | Bluetooth, WLAN, 802.11 b/g/n, RFID 2450, LTE Band 7 | Pulse modulation ^{b)} 217 Hz | 2 | 0,3 | 28 |
| 5 240 | 5 100 – 5 800 | WLAN 802.11 a/n | Pulse modulation ^{b)} 217 Hz | 0,2 | 0,3 | 9 |
| 5 500 | | | | | | |
| 5 785 | | | | | | |

NOTE If necessary to achieve the IMMUNITY TEST LEVEL, the distance between the transmitting antenna and the ME EQUIPMENT OF ME SYSTEM may be reduced to 1 m. The 1 m test distance is permitted by IEC 61000-4-3.

^{a)} For some services, only the uplink frequencies are included.
^{b)} The carrier shall be modulated using a 50 % duty cycle square wave signal.
^{c)} As an alternative to FM modulation, 50 % pulse modulation at 18 Hz may be used because while it does not represent actual modulation, it would be worst case.

The concentrator is intended for use in an environment where the radiated RF disturbances are controlled. Do not use the device near active HF surgical equipment and the RF shielded room of an ME system for magnetic resonance imaging, where the intensity of EM disturbances is high. Electromagnetic interference can be minimized by maintaining the distances described below based on the output of the equipment below.

If the system is compromised due to excessive RF disturbances, an alert or alarm condition may occur, and the device may power off.

RF cell frequencies used by this equipment include: LISA-C200 and SARA-R410

LISA-C200

| Parameter | Module | | Min | Max | Unit | Remarks |
|------------------------------|-----------|----------|------|------|------|-----------------|
| Frequency range CDMA 800 | LISA-C200 | Uplink | 824 | 849 | MHz | Module transmit |
| | LISA-C200 | Downlink | 869 | 894 | MHz | Module receive |
| Frequency range CDMA 1900 | LISA-C200 | Uplink | 1850 | 1910 | MHz | Module transmit |
| | LISA-C200 | Downlink | 1930 | 1990 | MHz | Module receive |

SARA-R410

| Parameter | | Min | Max | Unit | Remarks |
|--|----------|------|------|------|-----------------|
| Frequency range FDD Band 12 (700 MHz) | Uplink | 699 | 716 | MHz | Module transmit |
| | Downlink | 729 | 746 | MHz | Module receive |
| Frequency range FDD Band 17 (700MHz) | Uplink | 704 | 716 | MHz | Module transmit |
| | Downlink | 734 | 746 | MHz | Module receive |
| Frequency range FDD Band 28 (700MHz) | Uplink | 703 | 748 | MHz | Module transmit |
| | Downlink | 758 | 803 | MHz | Module receive |
| Frequency range FDD Band 13 (700MHz) | Uplink | 777 | 787 | MHz | Module transmit |
| | Downlink | 746 | 756 | MHz | Module receive |
| Frequency range FDD Band 20 (800MHz) | Uplink | 832 | 862 | MHz | Module transmit |
| | Downlink | 791 | 821 | MHz | Module receive |
| Frequency range FDD Band 26 (850MHz) | Uplink | 814 | 849 | MHz | Module transmit |
| | Downlink | 859 | 894 | MHz | Module receive |
| Frequency range FDD Band 18 (850MHz) | Uplink | 815 | 830 | MHz | Module transmit |
| | Downlink | 860 | 875 | MHz | Module receive |
| Frequency range FDD Band 5 (850MHz) | Uplink | 824 | 849 | MHz | Module transmit |
| | Downlink | 869 | 894 | MHz | Module receive |
| Frequency range FDD Band 19 (850MHz) | Uplink | 830 | 845 | MHz | Module transmit |
| | Downlink | 875 | 890 | MHz | Module receive |
| Frequency range FDD Band 8 (900MHz) | Uplink | 880 | 915 | MHz | Module transmit |
| | Downlink | 925 | 960 | MHz | Module receive |
| Frequency range FDD Band 4 (1700MHz) | Uplink | 1710 | 1755 | MHz | Module transmit |
| | Downlink | 2110 | 2155 | MHz | Module receive |
| Frequency range FDD Band 3 (1800MHz) | Uplink | 1710 | 1785 | MHz | Module transmit |
| | Downlink | 1805 | 1880 | MHz | Module receive |
| Frequency range FDD Band 2 (1900MHz) | Uplink | 1850 | 1910 | MHz | Module transmit |
| | Downlink | 1930 | 1990 | MHz | Module receive |
| Frequency range FDD Band 25 (1900MHz) | Uplink | 1850 | 1915 | MHz | Module transmit |
| | Downlink | 1930 | 1995 | MHz | Module receive |
| Frequency range FDD Band 39 (1900MHz) | Uplink | 1880 | 1920 | MHz | Module transmit |
| | Downlink | 1880 | 1920 | MHz | Module receive |
| Frequency range FDD Band 1 (2100MHz) | Uplink | 1920 | 1980 | MHz | Module transmit |
| | Downlink | 2110 | 2170 | MHz | Module receive |

RF GPS frequencies used by this equipment include:

Receiving only:

| | | |
|-------------|---------------------|--------------|
| 1575.42 MHz | 1598.6 – 1605.9 MHz | 1561.098 MHz |
|-------------|---------------------|--------------|

The following table lists the sound pressure levels as measured according to IEC 60601-1-8.

| Alarm | Sound Pressure Level |
|-----------------|----------------------|
| High Priority | 64.1 dB |
| Medium Priority | 63.0 dB |
| Low Priority | 61.8 dB |
| Device Mode | Sound Pressure Level |
| Continuous Mode | 77.1 dB |
| Pulse Mode | 78.3 dB |

INDEPENDENCE® – LIMITED WARRANTY STATEMENT

O2 Concepts, LLC (the "Company") warrants that each new Oxlife Independence® and the related accessories and replacement parts (each a "Product" and collectively, the "Products"), in each case purchased from the Company or its authorized distributor, shall be free from defects in materials and workmanship under normal use and service and when correctly maintained for the periods shown from the date of shipment ("Original Shipment Date") to the original purchaser ("Purchaser"), except as otherwise set forth herein. Subject to exclusions set forth herein, the applicable warranty coverages are set forth in the table below.

| Product | Warranty Period |
|---|--|
| Oxlife Independence® – New | Five (5) years from Original Shipment Date |
| Oxlife Independence® – Refurbished/Demo | Two (2) years from Original Shipment Date |
| Sieve Tubes | Two (2) years from Original Shipment Date |
| Standard Accessories (batteries ⁽¹⁾ , AC power supply, DC power supply, accessory bag) | One (1) year from Original Shipment Date |
| Optional Accessories (chargers, humidifiers, wheelchair bags, etc.) | Ninety (90) days from Original Shipment Date |
| Repaired and Replaced Products; Accessories | Later of ninety (90) days from Original Ship Date or remaining warranty period |
| Disposables (cannulas, filters, tubing) | No warranty |
| <i>⁽¹⁾ Warranty coverage limited to batteries that fall below 80% of associated rated capacity when fully charged.</i> | |

The limited warranties granted hereunder apply to Products purchased by the Purchaser and are not transferable. Purchaser's original purchase receipt for the Products are required for the limited warranties hereunder to be effective. For any limited warranty set forth herein to be effective, Purchaser shall inspect each Product within thirty (30) days of delivery and before such Product is placed into use. Purchaser agrees that the warranties provided by the Company with respect to any Product are subject to use of the Product in accordance with the Company's instructions as provided and that failure to do so shall void the warranties. The Company's sole liability and Purchaser's sole and exclusive remedy arising out of or relating to the Products, including for a breach of warranty, is limited to, at the Company's sole option, repair or replacement of the Product or part thereof which is returned to the Company at Purchaser's expense. This warranty shall apply only if Purchaser notifies the Company in writing, including email transmission, of the defective Product promptly after the discovery of the defect and within the warranty period. Products may be returned only by Purchaser and only when accompanied by an RMA reference number issued by the Company (see PRODUCT RETURN GUIDELINES at the end of this Statement). The Company will not be responsible for any alleged breach of warranty for which the Company determines to have arisen from a cause not covered by this warranty including, but not limited to,

those exceptions listed below. The Company shall make the final determination as to the existence and/or cause of any alleged defect.

For any Product that does not meet the limited warranty herein within the first ninety (90) days of the Original Shipment Date for the Product, Purchaser shall contact the Company to obtain an RMA reference number. Purchaser shall receive a replacement Product (which, solely at the Company's discretion, will be a new Product or a repaired Product built to a new specification) in advance of return of the failed Product. The Company will cover the shipping cost of the failed Product to the Company as well as the shipment of the replacement Product to the Purchaser. Purchaser will not be charged for the replacement Product provided Purchaser returns the failed Product in accordance with the Company's instructions within ten (10) business days of the issuance of an RMA reference number and the Company determines that such Product is covered by the limited warranty hereunder. If any failed Product is not returned in accordance with the Company's instructions within ten (10) business days from issuance of an RMA reference number or the Company determines that the Product is not covered by the limited warranty hereunder, the Company will invoice Purchaser for the list price of the replacement Product due and payable by Purchaser upon receipt.

For Product that does not meet the limited warranty herein after the ninetieth (90th) day after the Original Shipment Date, Purchaser shall contact the Company for an RMA reference number and return the Product within thirty (30) days of the issuance of an RMA reference number and in accordance with the Company's instructions at Purchaser's risk and expense. The Company shall examine the Product and, if the Product is covered by the limited warranty hereunder, the Company shall repair or replace the Product within a reasonable time, returning the Product to Purchaser at the Company's expense.

Defects and/or damage resulting from the following are expressly and specifically excluded from any warranty coverage hereunder.

Improper operation, improper storage, misuse, accident, alteration, abuse, neglect and/or physical damage, including, but limited to, exposure to smoke (including cigarette, cigar or e-cigarette smoke).

Ingress of liquids, sand, dirt, food, insects, animals or other foreign objects into the Product.

Exposure to unusual electrical stress, heat, humidity, condensation and/or cold.

Use in a manner that constitutes abnormal usage or conditions.

Failure to follow recommended preventative maintenance.

Unauthorized installation, repair or modification.

Use of parts, materials and accessories not provided or authorized by the Company.

Acts of God and/or other acts or conditions not in the control of the Company.

Moreover, warranty coverage shall not be extended to Products for which (i) the serial number label has been removed, altered or destroyed; (ii) tamper evident seals are broken; or (iii) mismatched serial numbers or revised combinations.

THE LIMITED WARRANTY SET FORTH HEREIN IS EXCLUSIVE AND IN LIEU OF ALL OTHER WARRANTIES OR REPRESENTATIONS, EXPRESS OR IMPLIED, EITHER IN FACT OR BY OPERATION OF LAW, STATUTORY OR OTHERWISE, INCLUDING WARRANTIES OF MERCHANTABILITY, FITNESS FOR A PARTICULAR PURPOSE AND NON-INFRINGEMENT. NO REPRESENTATION OR STATEMENT OF THE COMPANY MAY CHANGE OR ALTER THIS LIMITED WARRANTY UNLESS AGREED TO AND AUTHORIZED IN WRITING BY THE COMPANY.

The Company shall not be liable for any commercial losses, loss of revenues or profits, loss of goodwill, inconvenience, or exemplary, special, incidental, indirect, consequential or punitive damages whatsoever, or claims of third parties, regardless of the form of any claim, whether in contract or tort, whether from breach of this warranty, or defective equipment, or loss of data or from any other use, even if the Company has been advised or should be aware of the possibility of such damage. The Company's liability for loss or damages shall not exceed the purchase price paid by Purchaser for the particular Product giving rise to such liability.

The Company shall not be responsible for delays or failures in its performance resulting from Acts of God, war, riot, fire, explosion, accident, flood, sabotage, inability to obtain fuel, power, raw material or machinery, governmental laws, regulations, or labor disruption, strike, lockout or injunction, acts or omissions beyond the Company's control, including delays of suppliers or technical failure. If any such delay or failure occurs, the Company may allocate Products among the Company's customers at its sole discretion.

The validity, interpretation, and performance of these terms and conditions shall be governed by and construed under the applicable laws of the State of Oklahoma as if performed wholly within the state and without giving effect of the principles of conflict laws.

Except as provided otherwise herein, all disputes between the parties hereto shall be determined solely and exclusively by arbitration under, and in accordance with the rules then in effect of, the American Arbitration Association or any successors thereto ("AAA") in Oklahoma County, Oklahoma, unless the parties otherwise agree in writing. The parties shall jointly select an arbitrator. In the event the parties fail to agree upon an arbitrator within ten (10) days, then the Company shall select an arbitrator and Purchaser shall select an arbitrator and such arbitrators shall then select a third arbitrator to serve as the sole arbitrator, provided that if either the Company or Purchaser, in such event, fails to select an arbitrator within seven (7) days, such arbitrator shall be selected

by the AAA upon application of either the Company or Purchaser. Judgment upon the award of the agreed upon arbitrator or the so chosen third arbitrator, as the case may be, shall be binding and shall be entered into by a court of competent jurisdiction.

PRODUCT RETURN GUIDELINES

- Purchaser must contact the Company to obtain a Return Material Authorization ("RMA") reference number before returning any Product.
- The RMA reference number must be clearly identified on the outer shipping box.
- The Oxlife Independence® may only be returned in its original shipping box or a similar container with commercially reasonable packing protection.
- Any Product received without an RMA reference number will be refused by the Company.
- All COD shipments will be refused by the Company.
- Any Product received thirty (30) or more days after the date of issuance of an RMA reference number will be refused by the Company.

NOTES

Oxlife **INDEPENDENCE**®



O2 Concepts, LLC
199 Park Road Extension
Middlebury, CT 06762 USA



American Medical Sales and Rentals

15055 E. Hinsdale Drive,
Bldg D Centennial, CO 80112
Phone: +1 (877) 774-9271

www.oxygenconcentratorstore.com
E-mail: sales@amsrco.com



© 2019 O2 Concepts, LLC, all rights reserved; O2 Concepts®, Oxlife Independence®, and DNA Technology®, including certain related logos, are registered trademarks of O2 Concepts, LLC and may not be replicated without express written consent.